



Independent parking on 3 levels, with pit

### **UNIPARKER N5303**

No columns at the entry level  
so increased accessibility

Area of application:

residential buildings, hotels and office buildings

Standard

- load per platform max. 2000kg
- load per wheel max. 500kg

Optional

- load per platform max. 2600kg
- load per wheel max. 650kg

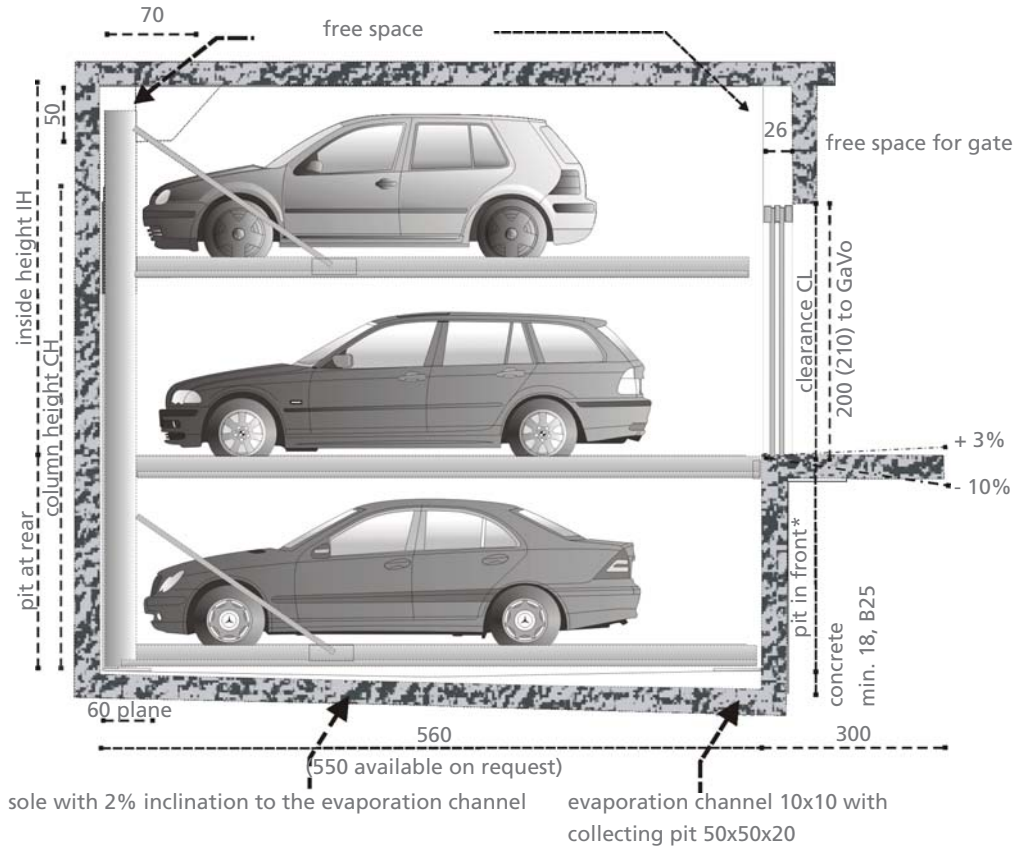

\*The pit in front should be executed more deeply than the pit at rear. The detail execution can be made individual.

pit in front	pit at rear	inside height IH	column height CH	car-height below	car-height middle	car-height above
175	175	340	475	150	160	160
175	175	370	490	150	175	175
175	175	400	505	150	190	190
175	175	430	520	150	205	205
185	185	370	500	160	175	175
185	185	400	515	160	190	190
185	185	430	530	160	205	205
200	200	400	530	175	190	190
200	200	430	545	175	205	205
210	210	430	555	185	205	205
220	220	430	565	195	205	205

■ standard

The mentioned above details to the vehicle height are maximum dimensions.

Columns only at the rear panel = direct power transmission:

less moving parts and high operating safety

Vehicle Data

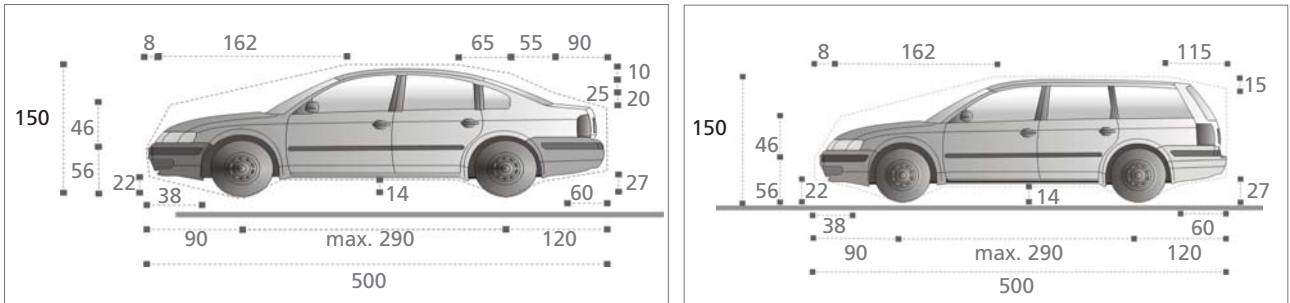

Standard: Car-width max. 190cm, load per platform max. 2000kg, load per wheel max. 500kg

Optional vehicle data: Car-length up to 520cm, load per platform max. 2600kg, load per wheel max. 650kg

Width dimensions, fig. 3 segments for 8 parking spaces

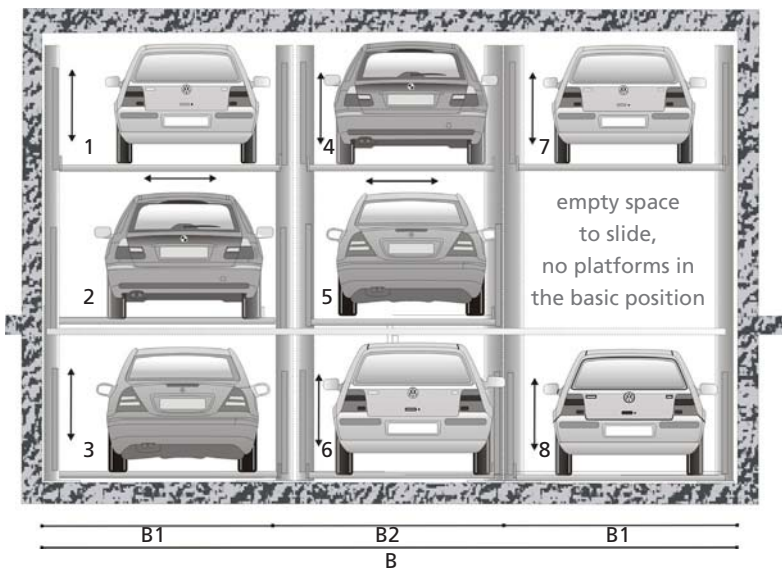

Positioning of the segments

The smallest unit are 2 segments for 5 cars. The system can be extended in any order. But we recommend to position not more than 10 segments for 29 cars side by side with one common hydraulic unit.

platform-width	raster outer B1	raster inner B2	3	total width dimensions B by x segments	4	5	6
230	260	250	770	1020	1270	1520	
240	270	260	800	1060	1320	1580	
250	280	270	830	1100	1370	1640	

■ standard

Functional description

The moving platforms in the pit and in the top level execute horizontal movements at the entrance level. The cylinder-controlled piston stroke sledge, with which these platforms are connected rigidly, effect a quiet run. The sliding platforms to slide sideways in the entrance level run on rail-controlled rollings. By the use of the empty space (one sliding platform under numb-

er of segments) the movement of the moving platforms is provided. The operation function by the use of the push button, with which the respective parking space will be dialled. In the automatic operation the platforms move when the gate is closed. The corresponding gate is approved to drive in and drive out of the system if the dialled platform stand by.

## Features in the scope of delivery



### Control element

Touch Screen with key-switch, emergency stop in dead man's control with brief operating instructions and wiring to the hydraulic unit.

### Hydraulic unit



Hydraulic unit "Silencio" with tubing and wiring to the installation.

The oil submerged motor is extremely quiet and smooth running. The motor-pump assembly is sound absorbent.

According to the local requirements – preferable placed near the rear columns/ cylinders

Dimensions: approx. 60cm x 22cm x 40cm

We recommend, according to the access times, to use max. 10 segments with one hydraulic unit.



### Driving plates

Driving plates as trapezoidal sheet plates as standard, options see "Extra Equipment".

### Scope of supply

Installation with sliding platforms and one empty space on the entrance level, on top and in the upper level with vertical moving platforms. Completely with hydraulic driving elements and electrical control elements.

### Drive of the platforms

2 lifting cylinders to drive the horizontal moving platforms with direct power transmission and without supporting parts (as chains and ropes), sliding platforms with electrical drive.

### Width of parking space

Width of parking space 230cm, pit depth 175cm and clearance 345cm as standard

### Safety devices

- entering wedges for easy drive-in and parking
- mechanical locking device prevents lowering by pipe breakage
- fixation of the installation and the hydraulic unit with HD-anchors, wiring and impact dowels

### Sliding gates

Sliding gates for fall-danger prevention into pit and railings for fall-danger prevention from the platform. (Notice: safe guarding against shearing and squeezing have priority and must provided by the proprietor sideways and behind the installation)

### Protection against corrosion

- Corrosion protection "Classic" of driving plates by continuous line-galvanizing to DIN EN 10142/10143.
- Corrosion protection "Classic Plus" of driving plates by line-galvanizing and powder coating to DIN EN 10142/10143 and surface coating on top (depending on the market specific needs zinc and powder coated sheet metal included in the scope of supply).

## Extra Equipment and Options

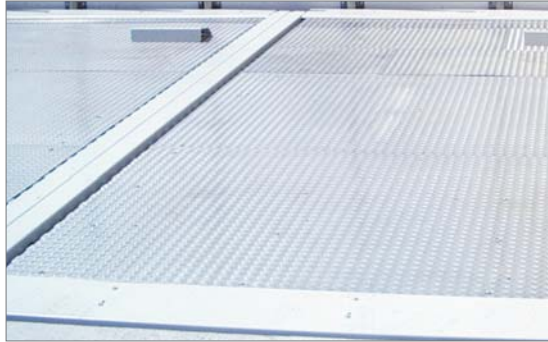

Driving plates  
Alu-bulb-plate in the walking area even more user friendly when walking and driving.



Positioning on the left side of the parking space even more comfortable, when walking to the driver's door. 1,5mm zined sheet, surface are coined. The catwalks are screwed to the driving plates, available with corrosion protection version "Classic" or "Classic Plus".  
Dimensions: approx. 350cm x 31/41 cm (L x W)

Modem for Teleservice/Online diagnosis  
With the Nussbaum CAN-BUS control system (delivery includes modem) remote maintenance and tele-service are possibilities.

This allows the Nussbaum parking experts a "tele-presence" at the customer in a matter of seconds for analysis and support.

(On site: modem/DSL connection Euro-DSL SO).

Width of parking space

Width of parking space 240 cm and 250 cm is recommended for even more vehicle comfort

Vehicle weight

Optional vehicle weight: up to 2600 kg

Additional sound insulation

- structure-borne noise package to comply with DIN 4109 and adherence to sound insulation-measure  $R_w$  '57
- sound insulation hood to minimize airborne sound

Hydraulic

- HVLP 32-330 oil for high fluctuations in temperature

Installation of gates

See detail, page 7

Ramp by installation of gates

Ramp by installation of gates behind the columns, pit length must be minimum 560 cm

Remote control for gates

Remote control and/or automatic-drive for sliding gates

Protection against corrosion

- Corrosion protection "Premium" of driving plates by individual piece-galvanizing to DIN ISO 1461.
- Corrosion protection "Premium Plus" of driving plates individual piece-galvanizing to DIN ISO 1461 and coating of the top surfaces.

Tips

- We recommend a maintenance contract.
- Attendance & cleaning according to recommendations or in regular intervals.

## Interfaces to be performed by the Buyer

### Foundation

Foundation works exactly to size, clean and dry is to be completed by the start of the installation. Bonded anchors for high foundation requirements shall be provided if necessary, available also as option.

### Foundation plan

back wall

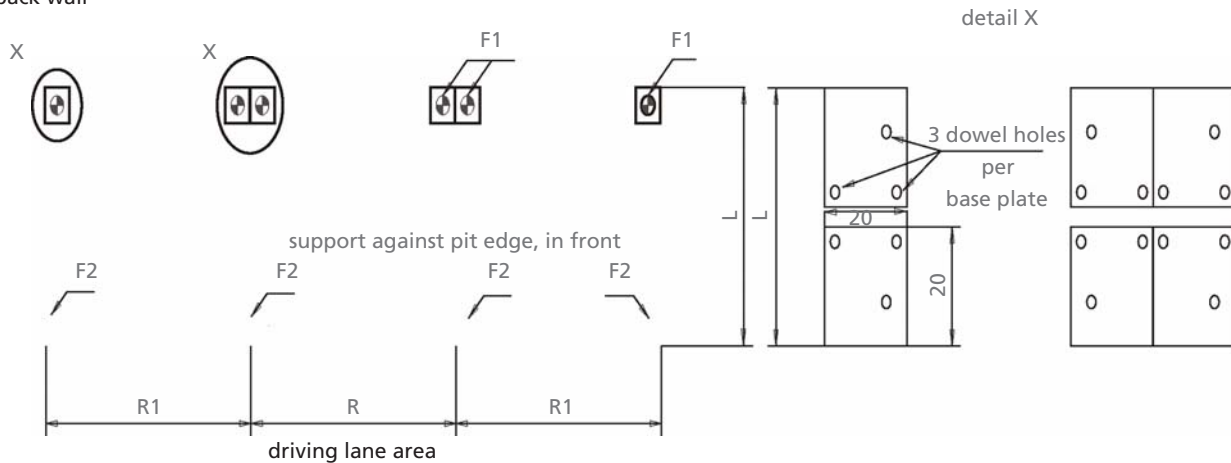

platform-width	raster R	raster outer R1	length L	force F1	moment F2
230	250	260	560*	45 kN	60 kNM
240	260	270	560*	45 kN	60 kNM
250	270	280	560*	45 kN	60 kNM

Dimensions in cm.

\*550 available on request

### Electrical data

- capacity of the hydraulic unit: 400volt, 50hz, three-phase motor 3,0 kW, mounting in the immediate nearness of the Car Parking System
- supply line to switch cabinet 5 x 2,5mm<sup>2</sup>, or to local requirements, fuse protection 3 x 16 amp, slow
- electrical potential equalisation (foundation grounding steel-construction to VDE 0100 T410)
- telephone line dto by modem and teleservice/online analysis available on request
- free space for switch cabinet LWH approx. 60cm x 22cm x 80cm, with pivot door in direct near of system (max. 6m) with access to the parking system

### General costumers duties

- level surface (H x W) 25cm x 26cm to attach the control panel, close to the system, outside the platform area
- safeguarding according to DIN EN 294
- lighting according to DIN 67528, illumination of parking lots and buildings for parking
- 10cm wide, yellow-black marking in front of each segment according to ISO 3864, insofar that no gates are installad
- compliance with installation requirements as per quotation
- foundation works exactly to size, clean and dry

## Gates for fall-danger prevention into the pit (in the scope of delivery)

Gates according to DIN EN 14010

According to DIN 14010 the Nussbaum Uniparker N 5003-IS must be closed with shutterdoors. The gate controls are integrated in the overall system.

Layout sliding gates

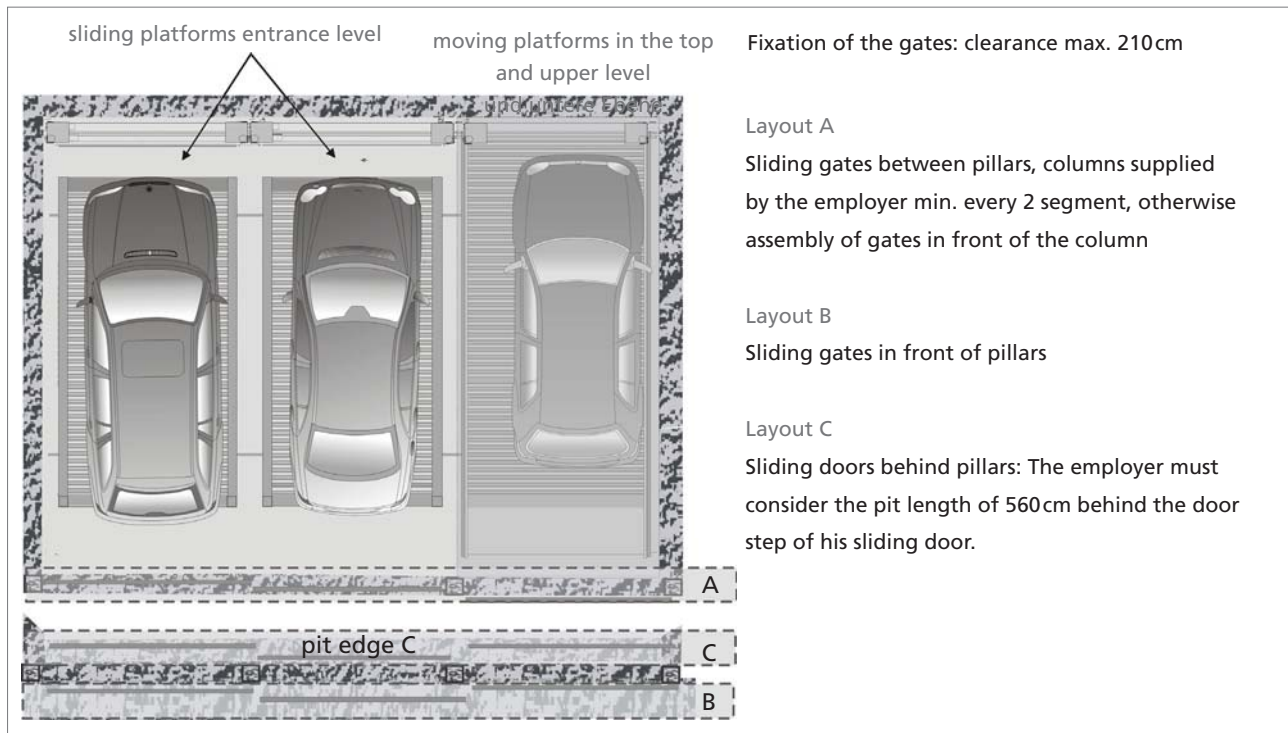

Advantages of Uniparker N5003-IS

Per segment are two columns at the rear panel only. In the entrance level no columns are needed. By the loss of these columns the driving into and driving out of the system is considerable eased.

The stability of the N5003-IS is guaranteed. This means that the columns behind will be fixed at the rear panel and in addition a horizontal bent column is assembled. This bent column initiate from the behind left column and the behind right column of two segments up to the pit front edge. The bent column is fixed between the

both segments. The IS-System needs less maintenance effort in comparison to competition car parking systems: The Uniparker-IS is void of power transmission parts such as chains and ropes. All vertical platforms are driven directly with hydraulic cylinders. Thus the need for springs, tensioners, slack switches and other safety mechanisms related to chains and ropes are eliminated; less to go wrong. The vertical platforms are also equipped with a warp and bend resistant frame rail which anticipates accidental lowering making additional locking mechanisms unnecessary.

# Electrical installation

Installation diagram, fig. 2 segments for 5 cars

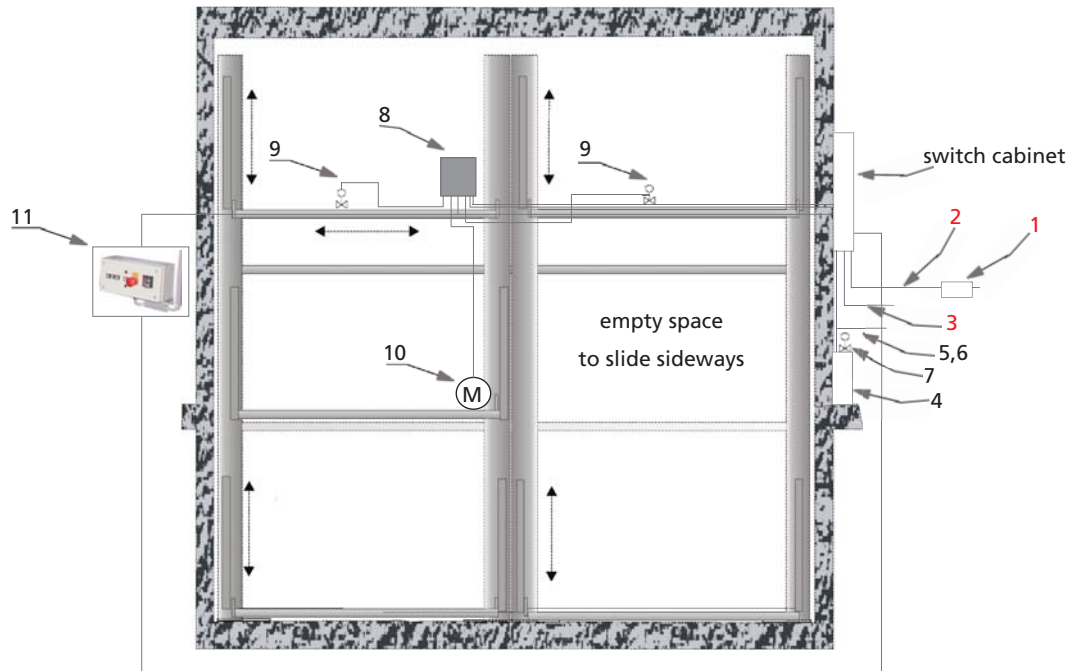

Item	Performance	Quantity	Designation	Location	Frequency
1	on site	1	fuse or automatic circuit 3 x 16 amp slow to DIN VDE 0100 part 430	in the feed cable	1x per system
2	on site	1	feed cable 5 G 1,5mm <sup>2</sup> or to local requirements	in the feed cable to the switch cabinet	1x per system
3	on site	1	potential equalization to DIN EN 60204	from foundation earth connector to the system	1x per system
4	Nussbaum	1	hydraulic unit with 3-phase motor 400volt, 50 Hz 3Kw		
5	Nussbaum	1	supply line 5 G 2,5mm <sup>2</sup> with marked wires and protective conductor	motor connector hydr. unit to switch cabinet	
6	Nussbaum	2	control line 2 x 1 <sup>2</sup>		
7	Nussbaum	2	hydraulic valve		
8	Nussbaum	1	segment box		
9	Nussbaum	2	segment valve	moving platform	
10	Nussbaum	1	electrical motor		
11	Nussbaum	1	control element with emergency stop		

The items 4-11 are included in the scope of supply, unless otherwise specified in the offer/order.